



Formschöne Scheibenleuchte mit schwenkbarem Gehäuse nach DIN EN 60598-1, DIN EN 60598-2-22 und DIN EN 1838 zur Kennzeichnung der Flucht- und Rettungswege. Für ein- oder zweiseitige Beschriftung. Erhältlich als LED-Zentralbatterie- oder LED-Einzelbatterie-Leuchte.

Elegant edge luminaire with swiveling body according to DIN EN 60598-1, DIN EN 60598-2-22 and EN 1838 for the marking of escape and rescue routes. For single or double sided labeling. Available for central power systems or as LED-self-contained emergency luminaire.

Gehäusematerial:	Aluminiumprofil, Zinkor weiß
Piktogramm:	Siebdruck RAL 6032
Schutzart/Schutzklasse:	IP40 / I
Montageart:	Universalmontage
Zulässige Umgebungtemp.:	-5° bis +40°C

Body:	<i>Aluminium inline profile, zinc steel sheet white</i>
Legend:	<i>Foil silk-screen printed RAL 6032</i>
Voltage:	<i>230V 50/60Hz</i>
Protection class / category:	<i>IP40 / I</i>
Mounting:	<i>universal mounting</i>
Permissible temp.:	<i>-5° up to +40°C</i>

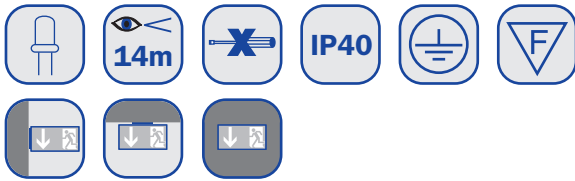

Aluminiumprofil-Scheibenleuchte Aluminium profiled edge luminaire

**Universal
Piktosatz
inklusive!**
Universal
pictograph set
included!

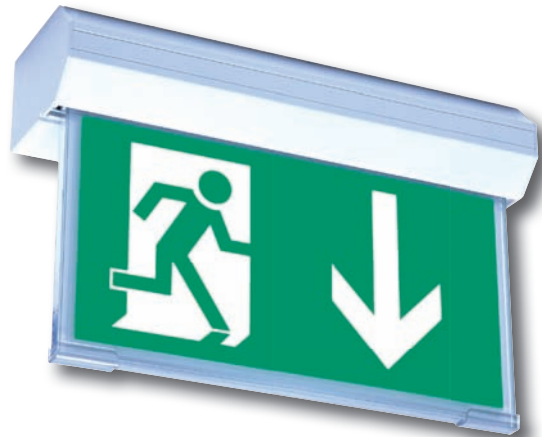
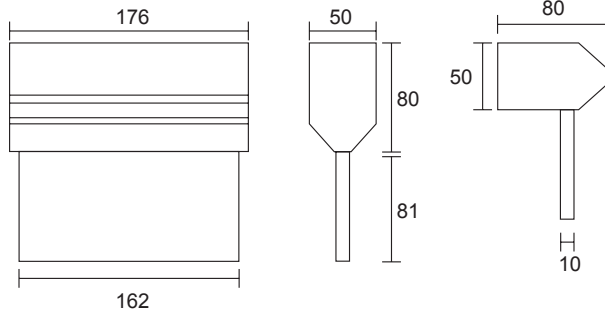

Ausführung Version	Bestellnummer Order number	Überbrückungszeit Operating time	Leuchtmittel Illuminant	Batterie Battery	Lumen Lumen	Gewicht kg Weight kg
Leuchten für Zentralanlagen - Luminaires for central power supply systems						
LED 230V AC/DC	RIU009	-	LED (1,5W)	-	-	0,5
Einzelbatterieleuchten - Self-contained luminaires						
LED 3h 230V AC	RIU003	3h	LED (1,5W)	3,6V / 0,5Ah	-	0,9

Option	Bestellnummer Order number
Design-Seilabhängung - Cord suspension	DSA

Bohrabstände RI Universal drilling distances RI universal

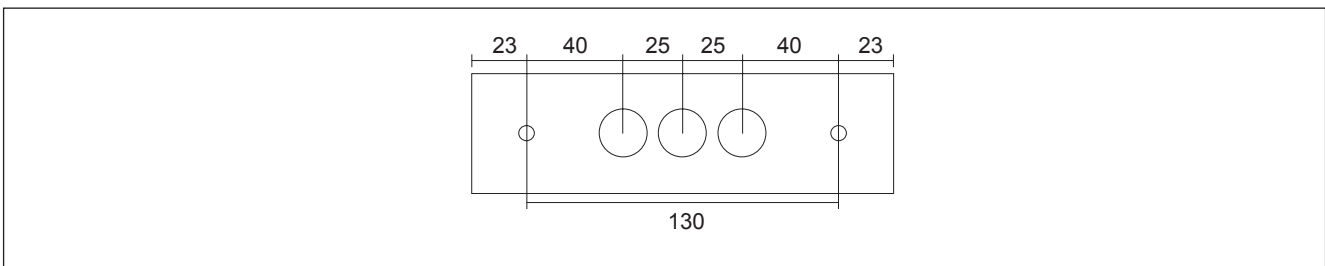

Zubehör Accessories

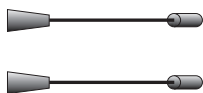



Formschöne Scheibenleuchte mit schwenkbarem Gehäuse nach DIN EN 60598-1, DIN EN 60598-2-22 und DIN EN 1838 zur Kennzeichnung der Flucht- und Rettungswege. Für ein- oder zweiseitige Beschriftung. Erhältlich als EVG- oder LED-Einzelbatterie-Leuchte.

Elegant edge luminaire with swiveling body according to DIN EN 60598-1, DIN EN 60598-2-22 and EN 1838 for the marking of escape and rescue routes. For single or double sided labeling. Available for central power systems or as LED-self-contained emergency luminaire.

Gehäusematerial:	Aluminiumprofil, Zinkor weiß
Piktogramm:	Siebdruck RAL 6032
Schutzart/Schutzklasse:	IP40 / I
Montageart:	Universalmontage
Zulässige Umgebungstemp.:	-5° bis +40°C

Body: Aluminium inline profile, zinc steel sheet white

Legend: Foil silk-screen printed RAL 6032

Protection class / category: IP40 / I

Mounting: universal mounting

Permissible temp.: -5° up to +40°C

Ausführung Version	Bestellnummer Order number	Überbrückungszeit Operating time	Leuchtmittel Illuminant	Batterie Battery	Lumen Lumen	Gewicht kg Weight kg
Leuchten für Zentralanlagen - Luminaires for central power supply systems						
6W 230V EVG	RMU612	-	6W LL	-	280	1,0
LED 230V AC/DC	RMU009	-	LED (2W)	-	-	0,9
Einzelbatterieleuchten - Self-contained luminaires						
LED 3h 230V AC	RMU003	3h	LED (2W)	4,8V / 1,3Ah	-	1,2



Aluminiumprofil-Scheibenleuchte Aluminium profiled edge luminaire

**Universal
Piktosatz
inklusive!**
Universal
pictograph set
included!

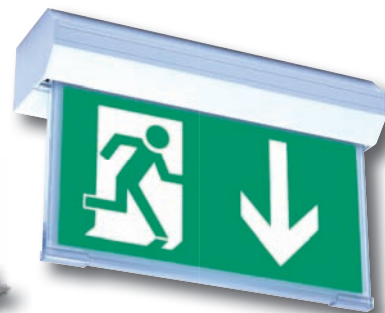

RM Wandmontage
RM wall mounted

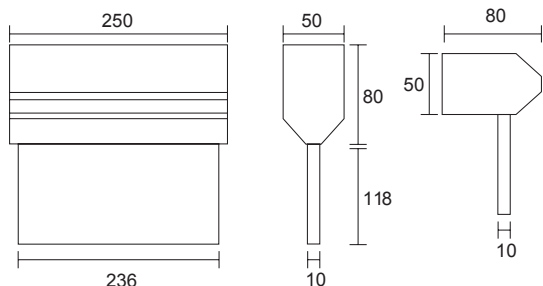

RMU mit Einbaurahmen RME
RMU with mounting frame RME

Option	Bestellnummer Order number
Einbaurahmen für Einbaumontage - mounting frame for recessed mounting	RME
Pendelpaar 500mm verchromt - Pair of pendants 500mm chromium plated	2PV
Wandausleger - wall bracket	AWW
Design-Seilabhängung - Cord suspension	DSA
Beton-Einputzkasten - concrete ceiling box	RMBE
Überwachung für Zentralanlagen - monitoring for central power supply systems	BL
Überwachung für Zentralanlagen (alle Schaltungsarten) - monitoring for central power supply systems (all modes)	ML
SELF-CONTROL für Einzelbatterie - SELF-CONTROL for self-contained luminaires	SC

Bohrabstände RM Universal drilling distances RM universal

Einbaurahmen RME recessed frame RME

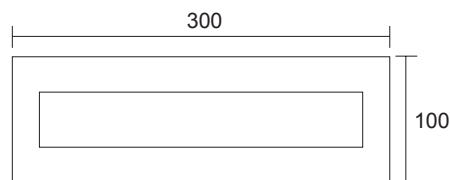
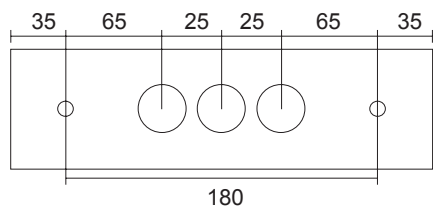

Deckenausschnitt / cut-out 280 x 80mm
Einbautiefe / installation depth 80 mm

Zubehör Accessories

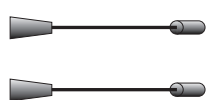
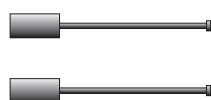



Formschöne Scheibenleuchte mit schwenkbarem Gehäuse nach DIN EN 60598-1, DIN EN 60598-2-22 und DIN EN 1838 zur Kennzeichnung der Flucht- und Rettungswege. Für ein- oder zweiseitige Beschriftung. Erhältlich als EVG- oder LED-Einzelbatterie-Leuchte.

Elegant edge luminaire with swiveling body according to DIN EN 60598-1, DIN EN 60598-2-22 and EN 1838 for the marking of escape and rescue routes. For single or double sided labeling. Available for central power systems or as LED-self-contained emergency luminaire.

Gehäusematerial:	Aluminiumprofil, Zinkor weiß
Piktogramm:	Siebdruck RAL 6032
Schutzart/Schutzklasse:	IP40 / I
Montageart:	Universalmontage
Zulässige Umgebungstemp.:	-5° bis +40°C

Body: Aluminium inline profile, zinc steel sheet white

Legend: Foil silk-screen printed RAL 6032

Protection class / category: IP40 / I

Mounting: universal mounting

Permissible temp.: -5° up to +40°C

Ausführung Version	Bestellnummer Order number	Überbrückungszeit Operating time	Leuchtmittel Illuminant	Batterie Battery	Lumen Lumen	Gewicht kg Weight kg
Leuchten für Zentralanlagen - Luminaires for central power supply systems						
8W 230V EVG	RXU818	-	8W LL	-	450	1,2
LED 230V AC/DC	RXU009	-	LED (3W)	-	-	1,2
Einzelbatterieleuchten - Self-contained luminaires						
LED 3h 230V AC	RXU003	3h	LED (3W)	4,8V / 1,3Ah	-	1,3



Aluminiumprofil-Scheibenleuchte Aluminium profiled edge luminaire

**Universal
Piktosatz
inklusive!**
Universal
pictograph set
included!

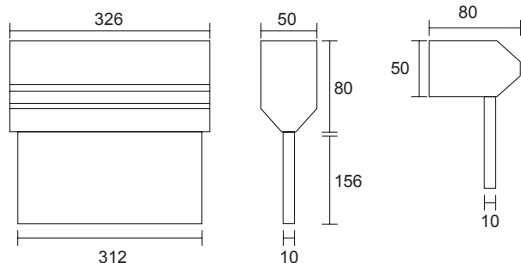

RX Wandmontage
RX wall mounted

RXU mit Einbaurahmen RXE
RXU with mounting frame RXE

Option	Bestellnummer Order number
Einbaurahmen für Einbaumontage - mounting frame for recessed mounting	RXE
Pendelpaar 500mm verchromt - Pair of pendants 500mm chromium plated	2PV
Wandausleger - wall bracket	AWW
Design-Seilaufhängung - Cord suspension	DSA
Beton-Einputzkasten - concrete ceiling box	RXBE
Überwachung für Zentralanlagen - monitoring for central power supply systems	BL
Überwachung für Zentralanlagen (alle Schaltungsarten) - monitoring for central power supply systems (all modes)	ML
Überwachung für Einzelbatterie BUS - monitoring for self-contained luminaires BUS	BC
SELF-CONTROL für Einzelbatterie - SELF-CONTROL for self-contained luminaires	SC

Bohrabstände RX Universal drilling distances RX universal

Einbaurahmen RXE recessed frame RXE

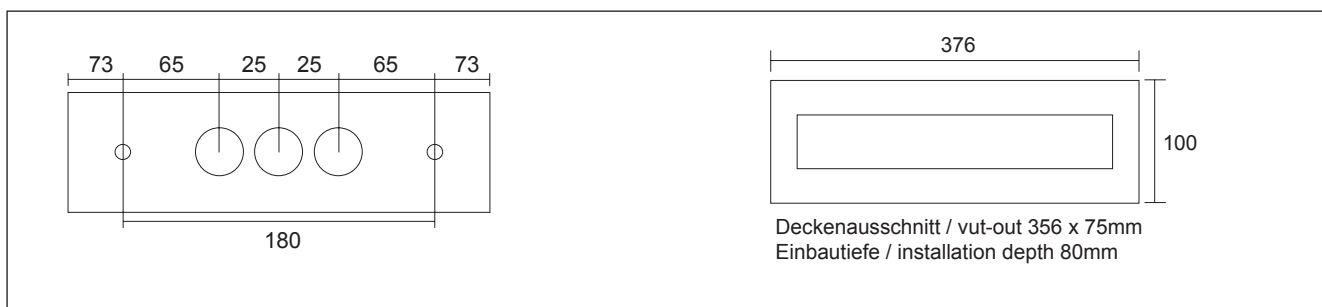

Zubehör Accessories

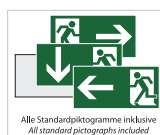

Auslaufmodell / Series is discontinued



Formschöne Scheibenleuchte nach DIN EN 60598-1, DIN EN 60598-2-22 und DIN EN 1838 zur Kennzeichnung und Ausleuchtung der Flucht- und Rettungswege. Für ein- oder zweiseitige Beschriftung. Erhältlich als EVG- oder LED-Einzelbatterie-Leuchte.

Gehäusematerial:	Aluminiumprofil, Zinkor
Standardfarbe:	weiß
Abmessungen (L x H x T):	SI: 190 x 153 x 58mm SD: 236 x 192 x 58mm SB: 312 x 233 x 58mm
Piktogramm:	Siebdruck RAL 6032
Erkennungsweite:	SI: 14m; SD: 22m; SB: 30m
Leuchtmittel:	SI: 4W LL oder LED (1,5 Watt) SD: 6W LL oder LED (2 Watt) SB: 8W LL oder LED (3 Watt)
Nennspannung:	230V 50/60Hz
Schutzart/Schutzklasse:	IP40 / I
Montageart:	Wand (W), Decke (D), Einbau (E), Pendel (P), Kette (K), Seil (S), Wandausleger AWS
Zulässige Umgebungstemp.:	-5° bis +40°C
Leergewicht:	0,4 bis 1,1 kg

Elegant edge luminaire according to DIN EN 60598-1, DIN EN 60598-2-22 and EN 1838 for the marking and lighting of escape and rescue routes. For single or double sided labeling. Available for central power systems or as LED-self-contained emergency luminaire.

Body:	Aluminium inline profile, zinc steel sheet
Standard color:	white
Dimensions (L x H x D):	SI: 190 x 153 x 58mm SD: 236 x 192 x 58mm SB: 312 x 233 x 58mm
Legend:	Foil silk-screen printed RAL 6032
Viewing distance:	SI: 14m; SD: 22m; SB: 30m
Illuminant:	SI: 4W LL oder LED (1,5 Watt) SD: 6W LL oder LED (2 Watt) SB: 8W LL oder LED (3 Watt)
Voltage:	230V 50/60Hz
Protection class / category:	IP40 / I
Mounting:	wall (w), ceiling (d), recessed (E), pendant fitting (P), chain (K), cord suspension (S), wall bracket AWS
Permissible temp.:	-5° up to +40°C
Weight empty:	0,4 to 1,1 kg

Aluminiumprofil-Scheibenleuchten Aluminium profiled edge luminaires



**Universal
Piktosatz
inklusive!**
Universal
pictograph set
included!

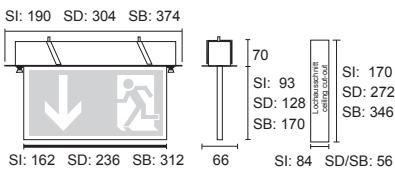
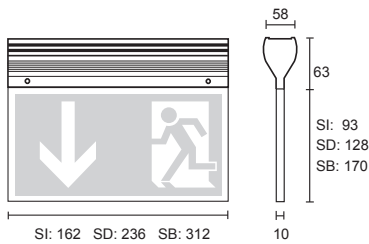

SI / SD / SB Einbau
SI / SD / SB recessed mounting

SI / SD / SB Decke
SI / SD / SB ceiling

Ausführung Version	Bestellnummer Order number	Überbrückungszeit Operating time	Leuchtmittel Illuminant	Batterie Battery	Lumen Lumen	Gewicht kg Weight kg
Leuchten für Zentralanlagen - Luminaires for central power supply systems						
4W 230V EVG	SI(W/D/K/S)406	-	4W LL	-	140	0,6
LED 230V AC/DC	SI(W/D/K/S)009	-	LED (1,5W)	-	-	0,5
6W 230V EVG	SD(W/D/E/K/P/S)612	-	6W LL	-	280	1,0
LED 230V AC/DC	SD(W/D/E/K/P/S)009	-	LED (2W)	-	-	0,9
8W 230V EVG	SB(W/D/E/K/P/S)818	-	8W LL	-	450	1,2
LED 230V AC/DC	SB(W/D/E/K/P/S)009	-	LED (3W)	-	-	1,2

Einzelbatterieleuchten - Self-contained luminaires						
LED 3h 230V AC	SI(W/D/E/K/S)003	3h	LED (1,5W)	4,8V / 0,3Ah	-	0,9
LED 3h 230V AC	SD(W/D/E/K/P/S)003	3h	LED(2W)	4,8V / 1,3Ah	-	1,2
LED 3h 230V AC	SB(W/D/E/K/P/S)003	3h	LED(3W)	4,8V / 1,3Ah	-	1,3

Option	Bestellnummer Order number
Pendelpaar 500mm verchromt - Pair of pendants 500mm chromium plated	2PV
Wandausleger (nicht für SI) - wall bracket (except SI)	AWS
Design-Seilauflängung - Cord suspension	DSA
Beton-Einputzkasten (nicht für SI) - concrete ceiling box (except SI)	SDBE / SBBE
Überwachung für Zentralanlagen (nicht für SI) - monitoring for central power supply systems (except SI)	BL
Überwachung für Zentralanlagen (alle Schaltungsarten - nicht für SI) - monitoring for central power supply systems (all modes) (except SI)	ML
Überwachung für Einzelbatterie BUS (nicht für SI) - monitoring for self-contained luminaires BUS (except SI)	BC
SELF-CONTROL für Einzelbatterie (nicht für SI) - SELF-CONTROL for self-contained luminaires (except SI)	SC

Zubehör Accessories



Neu ab Q3/2010 • New in 3rd quarter 2010
 Eine Leuchte – 3 Erkennungsweiten
 One luminaire – 3 viewing distances



①



②

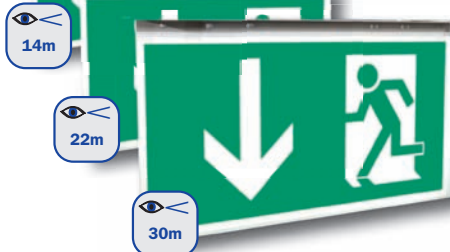

③

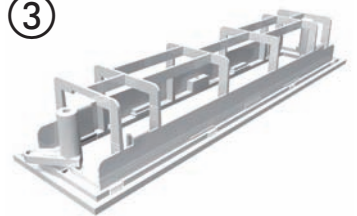

Bestellen Sie das Grundgehäuse als Sicherheitsleuchte mit der gewünschten Elektronik.
 Order the basic unit as safety luminaire with the desired electronic fitting.

Bestellen Sie das gewünschte Scheibenset
 Order the desired pictograph pane set

Optionaler Einbaurahmen
 Recessed mounting frame optional

Modulare Kunststoff Sicherheits-/ Rettungszeichen Scheibenleuchte für Universalmontage nach DIN EN 60598-1, DIN EN 60598-2-22 und DIN EN 1838 zur Kennzeichnung und Ausleuchtung der Flucht- und Rettungswege. Für ein- oder zweiseitige Beschriftung.

- Kombinierte Sicherheits- und Rettungszeichenleuchte ERT-LED Technik
- Ein Gehäuseunterteil für alle Scheibengrößen (bitte Scheibengröße bei der Bestellung angeben)
- Einfache Piktomontage (ein- und doppelseitig), Stecktechnik
- Einfacher Umbau von Sicherheits- zu Rettungszeichenleuchte

Modular plastic safety light / rescue sign edge luminaire for universal mounting according to DIN EN 60598-1, DIN EN 60598-2-22 and EN 1838 for the marking and lighting of escape and rescue routes. For single or double sided labeling.

- Combined safety light/rescue sign with ERT-LED
- One body fits all pane sizes (please specify pane size in your order)
- Simple pictogram mounting (one and double-sided), plugging-technique
- Easy conversion from safety to rescue sign luminaire

Gehäuse: Kunststoff, weiß (RAL 9003)

Piktogramm: Folie, Siebdruck RAL 6032

Schutzart/Schutzklasse: IP65 / II

Montageart: Universalmontage inkl. Wand, Decke, Einbau, Pendel

Zulässige Umgebungstemp.: -5° bis +40°C

Body: Plastic, white (RAL 9003)

Legend: Foil silk-screen printed RAL 6032

Protection class / category: IP65 / II

Mounting: Universal mounting incl. wall, ceiling, pendant fitting, recessed mounting

Permissible temp.: -5° up to +40°C

Ausführung Version	Bestellnummer Order number	Überbrückungszeit Operating time	Leuchtmittel Illuminant	Batterie Battery	Lumen lumen	Gewicht kg Weight kg
Leuchten für Zentralanlagen - Luminaires for central power supply systems						
LED 230V AC/DC	KBU019	-	LED (3W)	-	300	1,1
ERT-LED 230V	KBU029	-	LED (5x 1W)	-	300	1,1
Einzelbatterieleuchten - Self-contained luminaires						
LED 3h 230V AC	KBU013	3h	LED(3W)	4,8V / 2,0Ah	150	1,3
LED 8h 230V AC	KBU018	8h	LED(3W)	4,8V / 2,0Ah	75	1,3



Modulare Sicherheits-/ Rettungszeichenleuchte Modular safety light / rescue sign luminaire

Universal Piktosatz inklusive!
Universal pictograph set included!

Auch als ERT-Leuchte erhältlich!
Also available as ERT luminaire!

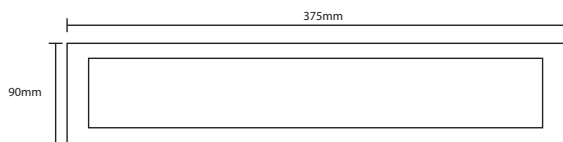

KB Einbaurahmen / KB recessed frame

KB Einbau / recessed mounting

Abstandstabelle KBU029 ERT-LED für ebene Fluchtwege Distance table KBU029 ERT-LED for plane emergency routes

Montagehöhe (m) Mounting level (m)					
2.00	4.29	10.90	9.51	7.08	2.86
2.50	4.70	11.99	10.39	7.77	3.09
3.00	4.99	12.92	11.10	8.37	3.33
3.50	5.19	13.68	11.68	8.94	3.62
4.00	5.31	14.34	12.14	9.44	3.86

Option

Bestellnummer Order number

Piktogrammscheiben-Set 14m - Pictograph pane set 14m	KBK
Piktogrammscheiben-Set 22m - Pictograph pane set 22m	KBM
Piktogrammscheiben-Set 30m - Pictograph pane set 30m	KBG
Einbaurahmen - recessed frame	KBE
Design-Seilabhängung (kein IP65 möglich) - Cord suspension (no IP65)	DSA
Pendelpaar 500mm verchromt/weiß (kein IP65 möglich) - Pair of pendants 500mm chromium plated/white (no IP65)	2PV / 2PW
Design-Pendelpaar vorverdrahtet (kein IP65 möglich) - Design pendant fitting prewired (no IP65) silber/weiß silver/white	2DS / 2DW
Überwachung für Zentralanlagen (alle Schaltungsarten) - monitoring for central power supply systems (all modes)	ML
Überwachung für Einzelbatterie BUS (auf Anfrage) - monitoring for self-contained luminaires BUS (on request)	BC
SELF-CONTROL für Einzelbatterie - SELF-CONTROL for self-contained luminaires	SC

Maße und Bohrabstände KB Wand / Decke Dimensions and drilling distances KB wall / ceiling

Lochausschnitt KB Einbaurahmen Hole cut-out KB recessed frame

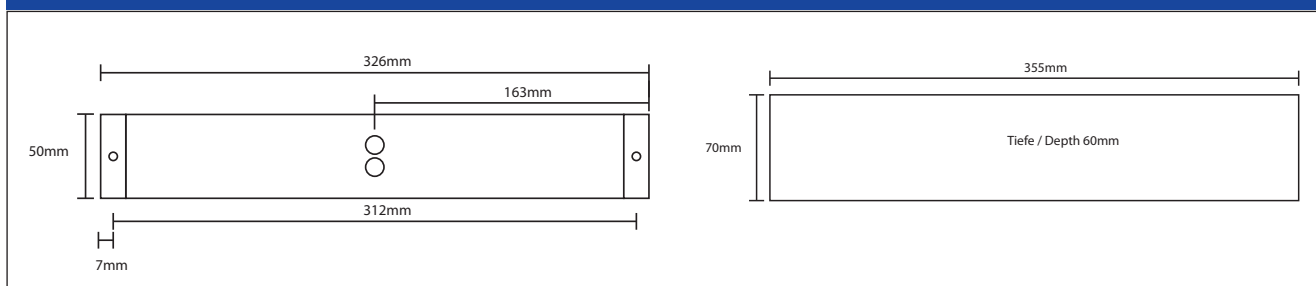

Zubehör Accessories

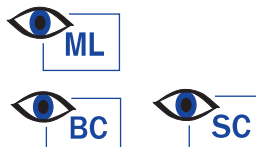
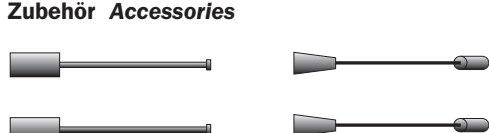

* - Nicht für den Einsatz in Schwimmbädern oder Schlachthöfen geeignet (nicht chlor- / chemikalienbeständig) | Bei Pendelmontage nur IP40.
Not suitable for use in pool areas or slaughterhouses (not chlorine- / chemical persistent) | With pendant fitting IP40 only.



Kunststoff-Scheibenleuchte für Universalmontage nach DIN EN 60598-1, DIN EN 60598-2-22 und DIN EN 1838 zur Kennzeichnung und Ausleuchtung der Flucht- und Rettungswege. Für ein- oder zweiseitige Beschriftung. Erhältlich als EVG- oder LED-Einzelbatterie-Leuchte.

- Als kombinierte Sicherheits- und Rettungszeichenleuchte mit ERT-LED erhältlich
- Einfache Piktomontage (ein- und doppelseitig), Stecktechnik

Plastic edge luminaire for universal mounting according to DIN EN 60598-1, DIN EN 60598-2-22 and EN 1838 for the marking and lighting of escape and rescue routes. For single or double sided labeling. Available for central power systems or as LED-self-contained emergency luminaire.

- Also available as combined safety light/rescue sign with ERT-LED
- Simple pictogram mounting (one and double-sided), plugging-technique

Gehäuse:	Kunststoff, weiß (RAL 9003)
Piktogramm:	Folie, Siebdruck RAL 6032
Schutzart/Schutzklasse:	IP40 / II
Montageart:	Universalmontage inkl. Wand, Decke, Wandausleger Optional: Pendel (P), Kette (K), Seil (S), Einbau (E)
Zulässige Umgebungstemp.:	-5° bis +40°C

Body:	Plastic, white (RAL 9003)
Legend:	Foil silk-screen printed RAL 6032
Protection class / category:	IP40 / II
Mounting:	Universal mounting incl. wall, ceiling, wall bracket Optional: pendant fitting (P), chain (K), cord suspension (S), recessed mounting (E)
Permissible temp.:	-5° up to +40°C

Ausführung Version	Bestellnummer Order number	Überbrückungszeit Operating time	Leuchtmittel Illuminant	Batterie Battery	Lumen lumen	Gewicht kg Weight kg
Leuchten für Zentralanlagen - Luminaires for central power supply systems						
8W 230V EVG	KXU818	-	8W LL	-	450	1,2
LED 230V AC/DC	KXU009	-	LED (3W)	-	150	1,1
ERT-LED 230V	KXU029	-	LED (5x 1W)	-	300	1,1
Einzelbatterieleuchten - Self-contained luminaires						
LED 3h 230V AC	KXU003	3h	LED(3W)	4,8V / 1,3Ah	150	1,3
LED 8h 230V AC	KXU018	8h	LED(3W)	12V / 0,8 Ah	150	1,3

Kunststoff-Scheibenleuchte Plastic edge luminaire

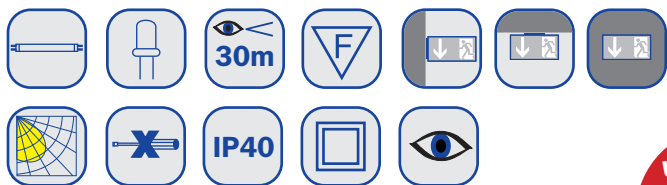

**Universal
Piktosatz
inklusive!**
Universal
pictograph set
included!

**Auch als
ERT-Leuchte
erhältlich!**
Also available as
ERT luminaire!

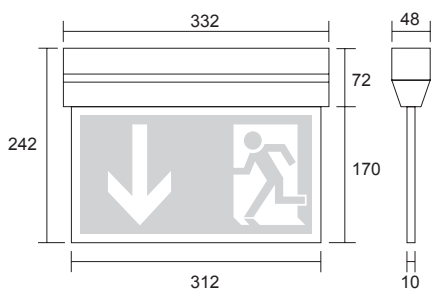

KXU029 - ERT-LED

Abstandstabelle KXU029 ERT-LED für ebene Fluchtwege
Distance table KXU029 ERT-LED for plane emergency routes

Montagehöhe (m) Mounting level (m)						
2.00	4.29	10.90	9.51	7.08	2.86	
2.50	4.70	11.99	10.39	7.77	3.09	
3.00	4.99	12.92	11.10	8.37	3.33	
3.50	5.19	13.68	11.68	8.94	3.62	
4.00	5.31	14.34	12.14	9.44	3.86	

Option	Bestellnummer Order number
Einbaurahmen - recessed frame	KXE
Einbaurahmen mit Prüftaster (Einzelbatterie) - recessed frame with check switch (self-contained)	KXE-EB
Opales Gehäuseunterteil (Ausleuchtung der Rettungswege) - opal cover (lighting of the escape routes)	KXOP
Glasklare Haube - Crystal Clear Cover	KXC
Design-Seilabhängung - Cord suspension	DSA
Pendelpaar 500mm verchromt/weiß - Pair of pendants 500mm chromium plated/white	2PV / 2PW
Design-Pendelpaar vorverdrahtet - Design pendant fitting prewired silber/weiß silver/white	2DS / 2DW
Überwachung für Zentralanlagen - monitoring for central power supply systems	BL
Überwachung für Zentralanlagen (alle Schaltungsarten) - monitoring for central power supply systems (all modes)	ML
Überwachung für Einzelbatterie BUS - monitoring for self-contained luminaires BUS	BC
SELF-CONTROL für Einzelbatterie - SELF-CONTROL for self-contained luminaires	SC

Bohrabstände KX Wand / Decke
Drilling distances KX wall / ceiling

KX Einbau
KX recessed

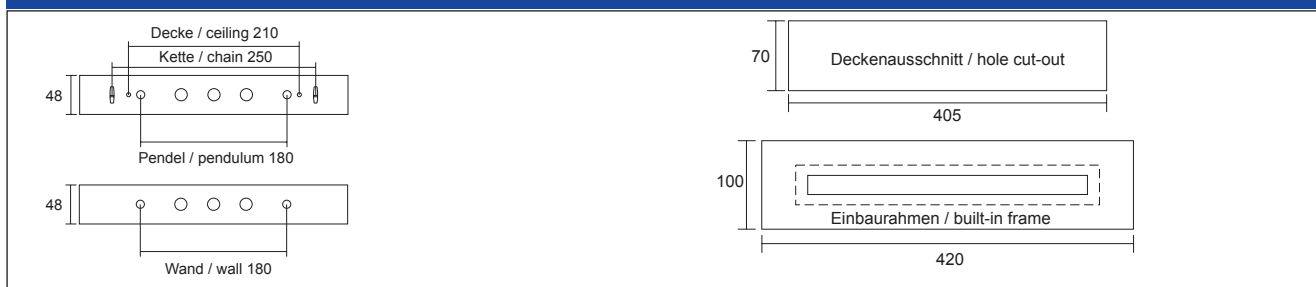

Zubehör Accessories





Abb. mit optionaler SELF-CONTROL für Einzelbatterieleuchten
Image shows optional SELF-CONTROL for self-contained luminaires

Kunststoff-Scheibenleuchte für Universalmontage nach DIN EN 60598-1, DIN EN 60598-2-22 und DIN EN 1838 zur Kennzeichnung der Flucht- und Rettungswege. Für ein- oder zweiseitige Beschriftung. Erhältlich als EVG- oder LED-Einzelbatterie-Leuchte.

- Elegantes Design
- Konstruktive Lebensdauer > 50.000 Std.
- Notlichtbrenndauer > 3 Std.
- LED-Technik mit weißen High-Power SMD-LED
- Für Durchgangsverdrahtung
- NiMH-Akkumulator ohne Memory-Effekt

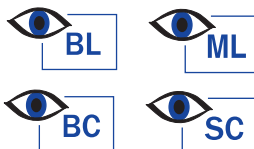
Gehäusematerial:	Kunststoff, weiß oder silber
Piktogramm:	Folie, Siebdruck RAL 6032
Schutzart/Schutzklasse:	IP54 / II
Montageart:	Universalmontage inkl. Wand, Decke, Wandausleger Optional: Pendel (P), Kette (K), Seil (S)
Zulässige Umgebungtemp.:	-5° bis +40°C

Plastic edge luminaire for universal mounting according to DIN EN 60598-1, DIN EN 60598-2-22 and EN 1838 for the marking of escape and rescue routes. For single or double sided labeling. Available for central power systems or as LED-self-contained emergency luminaire.

- Elegant design
- Constructive service lifetime > 50'000 h.
- > 3 h emergency lighting time
- LED technique with white High-Power SMD LED
- For transition wiring
- NiMH accumulator without memory effect

Body:	Plastic, white or silver
Legend:	Foil silk-screen printed RAL 6032
Protection class / category:	IP54 / II
Mounting:	Universal mounting incl. wall, ceiling, wall bracket Optional: pendant fitting (P), chain (K), cord suspension (S)
Permissible temp.:	-5° up to +40°C

Ausführung Version	Bestellnummer Order number	Überbrückungszeit Operating time	Leuchtmittel Illuminant	Batterie Battery	Farbe Color	Gewicht kg Weight kg
Leuchten für Zentralanlagen - Luminaires for central power supply systems						
LED 230V AC/DC	KSW009	-	LED (2W)	-	weiß/white	0,8
LED 230V AC/DC	KSS009	-	LED (2W)	-	silber/silver	0,8
Einzelbatterieleuchten - Self-contained luminaires						
LED 3h 230V AC	KSW003	3h	LED (2W)	3,6V / 0,5Ah	weiß/white	1,2
LED 3h 230V AC	KSS003	3h	LED (2W)	3,6V / 0,5Ah	silber/silver	1,2

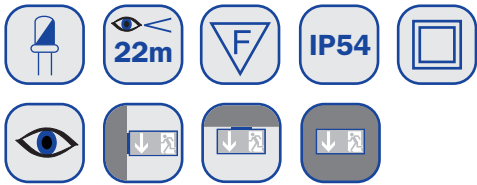

Universal Piktosatz inklusive!
 Universal pictograph set included!

Kunststoff-Scheibenleuchte Plastic edge luminaire

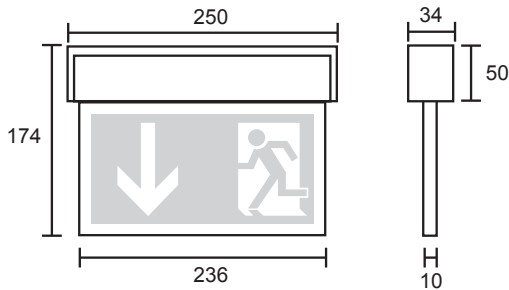

KS silber / silver

Option	Bestellnummer Order number
Einbaurahmen - recessed frame	KSE
Design-Pendelpaar vorverdrahtet - Design pendants prewired silber/weiß silver/white	2DS / 2DW
Design-Seilaufhängung - Cord suspension	DSA
Überwachung für Zentralanlagen (dimmbar) - monitoring for central power supply systems (dimmable)	DL
SELF-CONTROL für Einzelbatterie - SELF-CONTROL for self-contained luminaires	SC

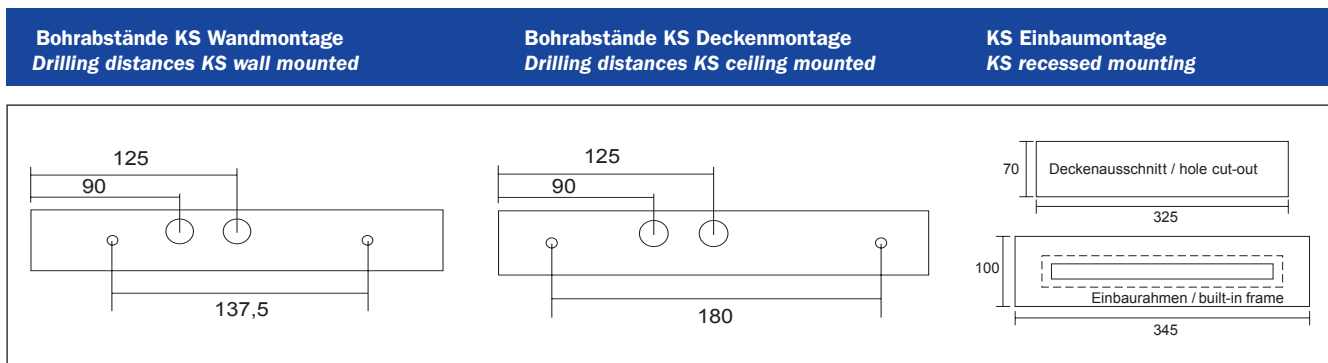

Zubehör Accessories

