



Kunststoff-LED-Rettungszeichenleuchte gem. DIN EN 60598-1, DIN EN 60598-2-22 und DIN EN 1838. Geeignet für Wand-, Decken-, oder Auslegermontage.  
Erhältlich als Einzelbatterieleuchte mit 3-stündigem Notbetrieb.

- Neueste LED-Technik garantiert gleichmäßige Ausleuchtung
- Lebensdauer des Leuchtmittels über 50.000 Std. reduziert Wartungskosten
- Geringe Stromaufnahme reduziert Energiekosten
- Schnelle Montage durch werkzeuglos zu öffnendes Gehäuse
- Universalpiktogramme im Lieferumfang enthalten

*Plastic LED emergency exit display luminaire acc. to DIN EN 60598-1, DIN EN 60598-2-22 and DIN EN 1838.*

*For ceiling, wall or wall bracket mounting.*

*Available as self-contained emergency luminaire for 3 hours emergency operation.*

- *Latest LED technology assures even legend illumination*
- *Up to 50,000 hours lamp life reduces maintenance costs*
- *Low power consumption reduces running costs*
- *Mounting plate for ease of installation*
- *Universal pictograms for all directions included*

<b>Gehäusematerial:</b>	Kunststoff, weiß
<b>Piktogramm:</b>	Folie Siebdruck RAL 6032
<b>Schutzart/Schutzklasse:</b>	IP54 / II
<b>Montagearten:</b>	Universalmontage inkl. Wand / Decke / Ausleger
<b>Zulässige Umgebungstemp.:</b>	-5° bis +35°C

<b>Body:</b>	Plastic, white
<b>Legend:</b>	Foil silk-screen printed RAL 6032
<b>Protection class / category:</b>	IP54 / II
<b>Mounting:</b>	Universal mounting incl. wall / ceiling / wall bracket
<b>Permissible temp.:</b>	-5° bis +35°C

## Universal-Kunststoffleuchte Universal Plastic luminaire

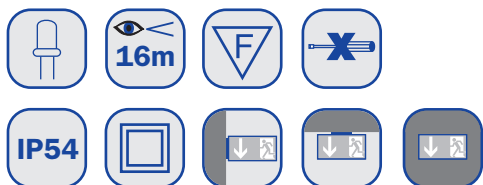

Universalmontage  
5 Jahre Garantie!  
Universal mounting  
5 years warranty!

**Universal Piktosatz inklusive!**  
Universal pictogram set included!

**Auch als ERT-Leuchte erhältlich!**  
Also available as ERT luminaire!

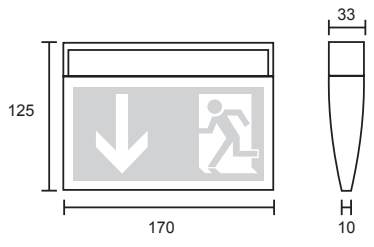

KTU

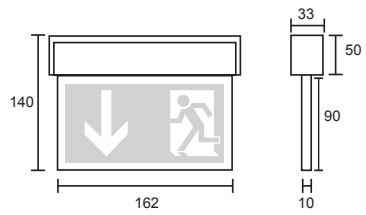

KTS



Auch als Scheibenleuchte KTS erhältlich  
Also available as edge luminaire KTS

Ausführung Version	Bestellnummer Order number	Überbrückungszeit Operating time	Leuchtmittel Illuminant	Batterie Battery	Montageart Mounting types	Gewicht kg Weight kg
<b>Einzelbatterieleuchten - Self-contained luminaires</b>						
LED/3h 230V AC	KTU003	3h	LED (1,5W)	4,8V/0,3Ah	Universal	0,25
LED/3h 230V AC	KTS003	3h	LED (1,5W)	4,8V/0,3Ah	Universal	0,25

Option	Bestellnummer Order number
Design-Seilabhängung (Standardlänge 1,5 m) - Cord suspension (standard length 1,5 m)	DSA
Pendel 500 mm verchromt/weiß - Pendant fitting 500 mm chromium plated/white	1PV/1PW

### Bohrabstände KT Decke/Wand Drilling distances KT ceiling/wall

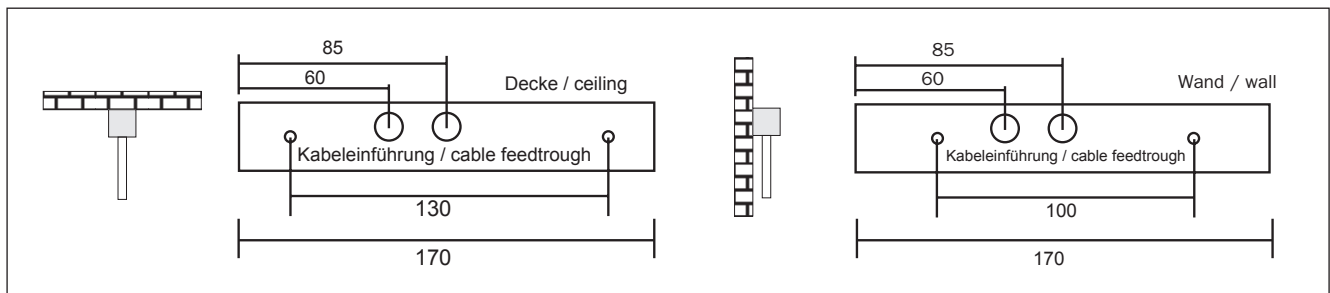

### Zubehör Accessories

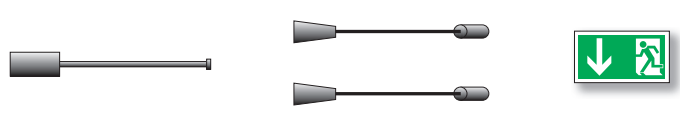



Schlanke konvexe Kunststoffleuchte für Universalmontage zur Kennzeichnung der Flucht- und Rettungswege für ein- oder zweiseitige Beschriftung. Erhältlich als AC/DC- oder Einzelbatterie-Leuchte.

*Slim convex plastic luminaire for universal mounting for the marking of escape and rescue routes for single or double sided labeling. Available for central power systems or as self-contained emergency lighting.*

- Alle Montagearten (Wand, Decke, Ausleger)
- Pendelmontage mit optionalem Pendelsatz
- Elegantes Design (Geschmacksmusterschutz)
- Konstruktive Lebensdauer > 50000 Std.
- Notlichtbrenndauer > 3 Std.
- 4er-Piktosatz inklusive (unten, rechts, links, weiß)
- Einfache Piktomontage (ein- und doppelseitig), Stecktechnik
- Perfekte Piktorausleuchtung gem. DIN EN 60598-1
- LED-Technik mit weißen High-Power SMD-LED

- *All mounting possibilities (wall, ceiling, wall bracket)*
- *Pendant fitting mounting with optional pendant fitting sentence*
- *Elegant design (protected)*
- *Constructive service lifetime > 50000 h.*
- *> 3 h emergency lighting time*
- *Including 4 pictograms (below, to the right, to the left, white)*
- *Simple pictogram mounting (one and double-sided), plugging-technique*
- *Perfect tenses pictogram illumination in accordance to DIN EN 60598-1*
- *LED technique with white High-Power SMD LED*

<b>Gehäusematerial:</b>	Kunststoff, weiß
<b>Piktogramm:</b>	Folie Siebdruck RAL 6032
<b>Schutzart/Schutzklasse:</b>	IP54 / II
<b>Montageart:</b>	Decke / Wand / Ausleger Optional: Pendel / Kette / Seil
<b>Zulässige Umgebungstemp.:</b>	-5° bis +40°C

<b>Body:</b>	Plastic, white
<b>Legend:</b>	Foil silk-screen printed RAL 6032
<b>Protection class / category:</b>	IP54 / II
<b>Mounting:</b>	ceiling / wall / wall bracket pendant / chain / rope optionally
<b>Permissible temp.:</b>	-5° up to +40°C

Ausführung Version	Bestellnummer Order number	Überbrückungszeit Operating time	Leuchtmittel Illuminant	Batterie Battery	Lumen Lumen	Gewicht kg Weight kg
<b>Leuchten für Zentralanlagen AC/DC - Luminaires for central power supply systems AC/DC</b>						
LED 230V AC/DC	KMU009	-	LED (2W)	-	-	0,4
<b>Einzelbatterieleuchten - Self-contained luminaires</b>						
LED/3h 230V AC	KMU003	3h	LED (2W)	3,6V/0,5Ah	-	0,5
LED/8h 230V AC	KMU008	8h	LED (2W)	3,6V/0,5Ah	-	0,5

## Universal-Kunststoffleuchte Universal Plastic luminaire

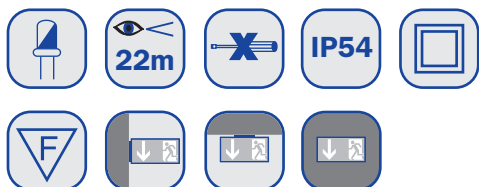

**Universal  
Piktosatz  
inklusive!**  
Universal  
pictograph set  
included!

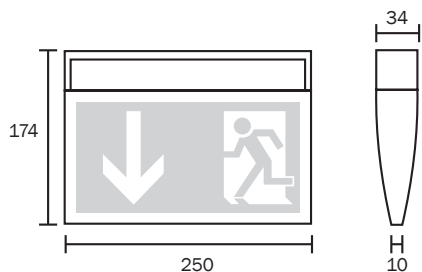

Option	Bestellnummer Order number
Design-Seilabhängung (Standardlänge 1,5 m) - Cord suspension (standard length 1,5 m)	DSA
Pendelpaar 500 mm verchromt/weiß - Pendant fitting 500 mm chromium plated/white	2PV/2PW
Designpendelpaar 500 mm silber/weiß - Design Pendant fitting prewired silver/white	2DS/2DW
Überwachungsbaustein für Zentralanlagen (dimmbar) - Monitoring module for central power supply systems (dimmmable)	DL
Selbstüberwachungsbaustein SELF-CONTROL - Integral control module SELF-CONTROL	SC

### Bohrabstände KM Decke/Wand Drilling distances KM ceiling/wall

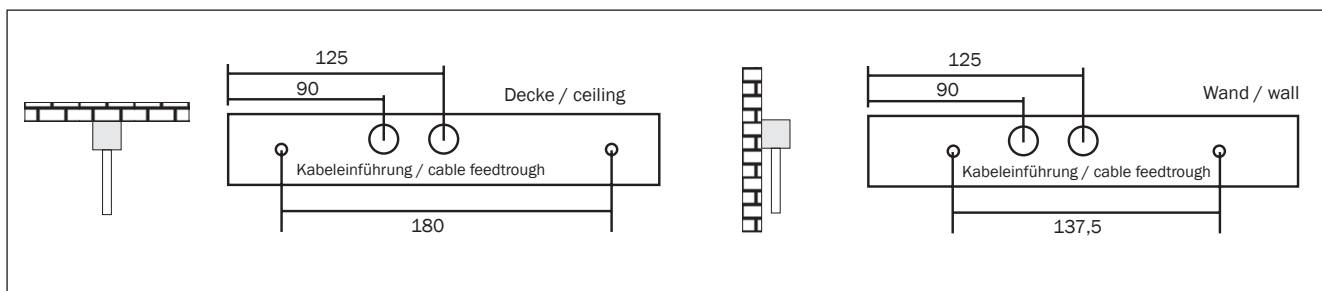

### Zubehör Accessories

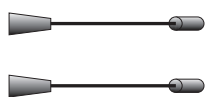



Kunststoff-Rettungszeichen bzw. Sicherheitsleuchte mit High-Power LED's für Wand- oder Deckenmontage nach DIN EN 60598-1, DIN EN 60598-2-22 und DIN EN 1838 zur Kennzeichnung und Ausleuchtung der Flucht- und Rettungswege. Erhältlich als AC/DC- oder Einzelbatterie-Leuchte. Der Abstand zwischen Piktoscheibe und Leuchtmittel ist universell verstellbar.

Plastic luminaire for wall or ceiling mounting with High-Power LED according to DIN EN 60598-1, DIN EN 60598-2-22 and EN 1838 for the marking and lighting of escape and rescue routes. Available for central power systems or self-contained emergency luminaire. The distance between the illuminant and the pictograph is adjustable.

<b>Gehäuse:</b>	Kunststoff, weiß
<b>Piktogramm:</b>	Siebdruck RAL 6032
<b>Schutzart/Schutzklasse:</b>	IP40 / II
<b>Montageart:</b>	Wand, Decke Optional: Einbau (E)
<b>Zulässige Umgebungtemp.:</b>	-5° bis +35°C

<b>Body:</b>	Plastic, white
<b>Legend:</b>	silk-screen printed RAL 6032
<b>Protection class / category:</b>	IP40 / II
<b>Mounting:</b>	wall, ceiling Optional: recessed mounting
<b>Permissible temp.:</b>	-5° up to +35°C

Ausführung Version	Bestellnummer Order number	Überbrückungszeit Operating time	Leuchtmittel Illuminant	Batterie Battery	Lumen lumen	Gewicht kg Weight kg
<b>Leuchten für Zentralanlagen - Luminaires for central power supply systems</b>						
LED 230V AC/DC	KIU009	-	LED (1,5W)	-	60	0,4
<b>Einzelbatterieleuchten - Self-contained luminaires</b>						
LED 3h 230V AC	KIU003	3h	LED (1,5W)	4,8V / 0,3Ah	30	0,5

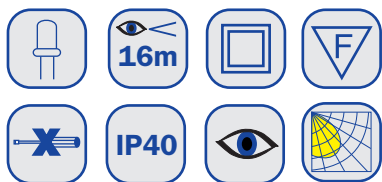

**Universal Piktosatz inklusive!**  
Universal pictograph set included!

**Auch als ERT-Leuchte erhältlich!**  
Also available as ERT luminaire!

## Kunststoff-Leuchte Plastic luminaire

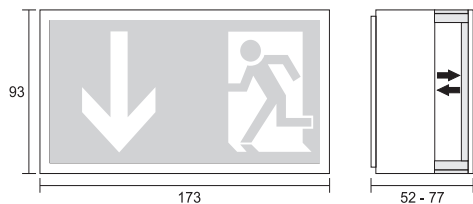

KI Wand/Decke wall/ceiling

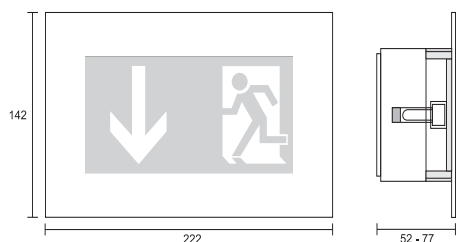

KI Einbau / recessed



KI Einbau / recessed



Option	Bestellnummer Order number
Einbaurahmen - recessed frame	KIE
Überwachung für Zentralanlagen - monitoring for central power supply systems	BL
Überwachung für Zentralanlagen (alle Schaltungsarten) - monitoring for central power supply systems (all modes)	ML

### Bohrabstände KI Wand / Decke Drilling distances KI wall / ceiling

### KI Einbau KI recessed mounting

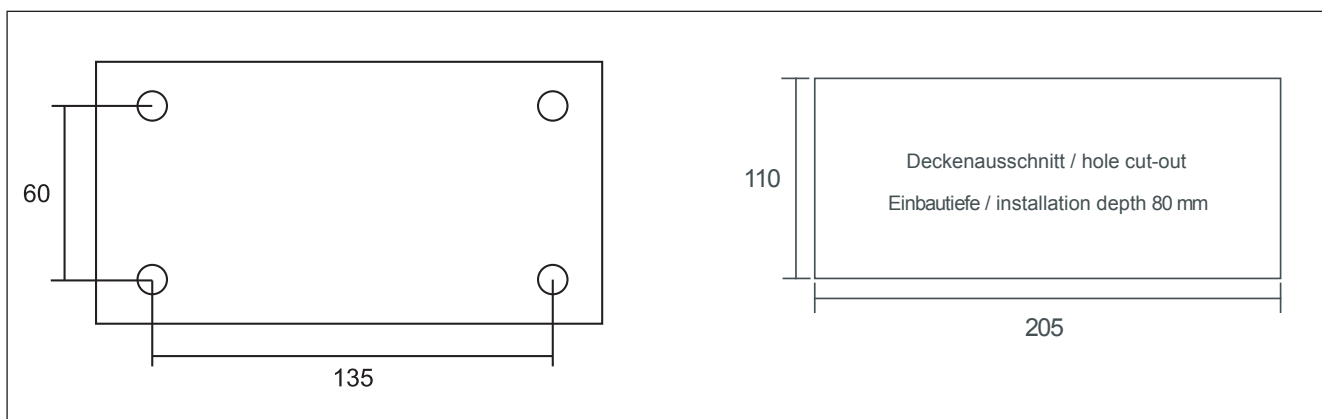

### Zubehör Accessories





Schlanke konvexe Kunststoffleuchte zur Kennzeichnung und Ausleuchtung der Flucht- und Rettungswege nach DIN EN 60598-1, DIN EN 60598-2-22 und DIN EN 1838. Für ein- oder zweiseitige Beschriftung. Erhältlich als EVG- oder Einzelbatterie-Leuchte.

*Slim convex plastic luminaire for the marking and lighting of escape and rescue routes according to DIN EN 60598-1, DIN EN 60598-2-22 and EN 1838. For single or double sided labeling. Available for central power systems or as self-contained emergency luminaire.*

<b>Gehäuse:</b>	Kunststoff, weiß
<b>Piktogramm:</b>	Folie, Siebdruck RAL 6032
<b>Reflektor:</b>	Spiegelreflektor
<b>Schutzart/Schutzklasse:</b>	IP54 / II (optional IP65) Decke IP40
<b>Montageart:</b>	Wand (W), Decke (D), Einbau (E), Pendel (P), Kette (K), Seil (S), Wandausleger AWS
<b>Zulässige Umgebungstemp.:</b>	-5° bis +40°C

<b>Body:</b>	Plastic, white
<b>Legend:</b>	Foil, silk-screen printed RAL 6032
<b>Reflector:</b>	mirror reflector
<b>Protection class / category:</b>	IP54 / II (optionally IP65) ceiling IP40
<b>Mounting:</b>	wall (W), ceiling (D), recessed (E), pendant fitting (P), Chain (K), cord suspension (S), wall bracket
<b>Permissible temp.:</b>	-5° up to +40°C

Ausführung Version	Bestellnummer Order number	Überbrückungszeit Operating time	Leuchtmittel Illuminant	Batterie Battery	Lumen lumen	Gewicht kg Weight kg
<b>Leuchten für Zentralanlagen - Luminaires for central power supply systems</b>						
8W 230V EVG	KC(W/D/E/P/K/S)818	-	8W LL	-	450	0,7
11W 230V EVG	KC(W/D/E/P/K/S)825	-	11W CFL	-	900	0,8
LED 230V AC/DC	KC(W/D/E/P/K/S)019	-	LED (3W)	-	150	0,7
<b>Einzelbatterieleuchten - Self-contained luminaires</b>						
8W/3h 230V AC	KC(W/D/E/P/K/S)803	3h	8W LL	3,6V / 3,3Ah	260	1,0
LED 3h 230V AC	KC(W/D/E/P/K/S)013	3h	LED (3W)	12V / 0,8Ah	150	1,0
LED 8h 230V AC	KC(W/D/E/P/K/S)018	8h	LED (3W)	12V / 0,8Ah	75	1,0

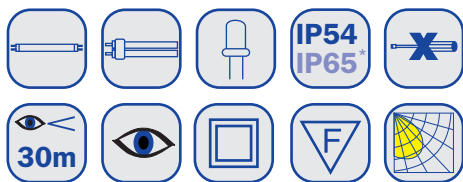

## Kunststoff-Leuchte Plastic luminaire

**Universal  
Piktosatz  
inklusive!**  
Universal  
pictograph set  
included!

**Auch erhältlich als KC Cool  
speziell für Kühlhäuser**  
**Also available as KC Cool  
for cold storage houses**

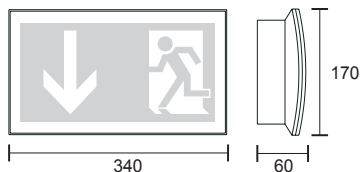

KC Wand / wall



KC Prismatic / prismatic



KC Wand / wall

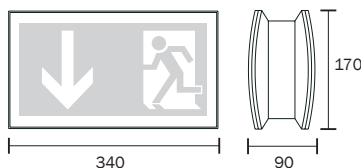

KC Decke / ceiling



KC Einbau / recessed

Option	Bestellnummer Order number
Schutzart IP65 - Protection class IP65	KCIP65
Ballschutzkorb (nur Wand) - ball protection (wall only)	BALL2
KC Cool (IP65, Wandmontage) - KC Cool (IP65, wall mounting)	KCC
Einbaurahmen - recessed frame	KCER
Unterputz- und Betoneinbaukasten inkl. Einbaurahmen - flush mounting and concrete plaster box incl. recessed frame	KCBE
Pendelpaar 500mm verchromt - Pair of pendants 500mm chromium plated	2PV
Wandausleger - wall bracket	KCAWW
Design-Seilaufhängung - Cord suspension	DSA
Überwachung für Zentralanlagen - monitoring for central power supply systems	BL
Überwachung für Zentralanlagen (alle Schaltungsarten) - monitoring for central power supply systems (all modes)	ML
Überwachung für Einzelbatterie BUS - monitoring for self-contained luminaires BUS	BC
SELF-CONTROL für Einzelbatterie - SELF-CONTROL for self-contained luminaires	SC

### Bohrabstände KC Wand Drilling distances KC wall

### Bohrabstände KC Decke Drilling distances KC ceiling

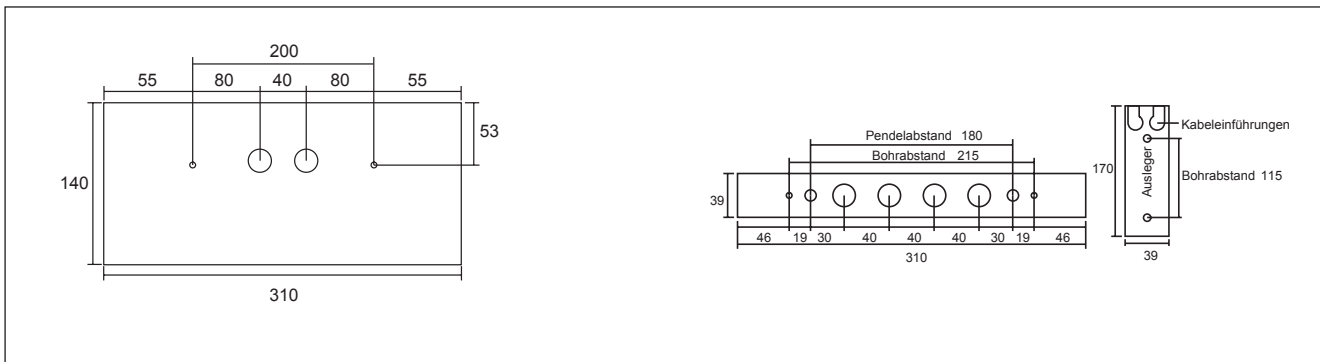

### Zubehör Accessories

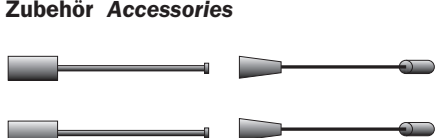

\* - Nicht für den Einsatz in Schwimmbädern oder Schlachthöfen geeignet (nicht chlor- / chemikalienbeständig)  
Not suitable for use in pool areas or slaughterhouses (not chlorine- / chemical persistent)



Schlanke Kunststoffleuchte für Universalmontage zur Kennzeichnung und Ausleuchtung der Flucht- und Rettungswege nach DIN EN 60598-1, DIN EN 60598-2-22 und DIN EN 1838. Für ein- oder zweiseitige Beschriftung. Erhältlich als EVG- oder Einzelbatterie-Leuchte.

*Slim plastic luminaire for universal mounting for the marking and lighting of escape and rescue routes according to DIN EN 60598-1, DIN EN 60598-2-22 and EN 1838. For single or double sided labeling. Available for central power systems or as self-contained emergency luminaire.*

<b>Gehäusematerial:</b>	Kunststoff, weiß (oder silber)
<b>Piktogramm:</b>	Folie, Siebdruck RAL 6032
<b>Reflektor:</b>	weiß inkl.,
<b>Schutzart/Schutzklasse:</b>	IP54 / II
<b>Montageart:</b>	Universalmontage inkl. Wand, Decke, Wandausleger, Optional: Pendel (P), Kette (K), Seil (S)
<b>Zulässige Umgebungstemp.:</b>	-5° bis +40°C

<b>Body:</b>	<i>Plastic, white (or silver)</i>
<b>Legend:</b>	<i>Foil, silk-screen printed RAL 6032</i>
<b>Protection class / category:</b>	<i>IP54 / II</i>
<b>Mounting:</b>	<i>Universal mounting incl. wall, ceiling, wall bracket Optionally: Pendant fitting (P), chain (K), cord suspension (S)</i>
<b>Permissible temp.:</b>	<i>-5° up to +40°C</i>

Ausführung Version	Bestellnummer Order number	Überbrückungszeit Operating time	Leuchtmittel Illuminant	Batterie Battery	Lumen lumen	Gewicht kg Weight kg
<b>Leuchten für Zentralanlagen - Luminaires for central power supply systems</b>						
6W 230V EVG	KDU612	-	6 W LL	-	280	0,7
11W 230V EVG	KDU625	-	11W CFL	-	900	0,75
LED 230V AC/DC	KDU019	-	LED (3W)	-	150	0,7
<b>Einzelbatterieleuchten - Self-contained luminaires</b>						
6W/3h 230V AC	KDU603	3h	6W LL	3,6V / 3,3Ah	200	1,2
LED 3h 230V AC	KDU013	3h	LED (3W)	12V / 0,8Ah	150	1,0
LED 8h 230V AC	KDU018	8h	LED (3W)	12V/ 0,8Ah	75	1,0



## Universal-Kunststoffleuchte Universal Plastic luminaire

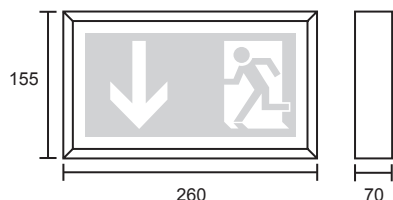

KD Wand / wall

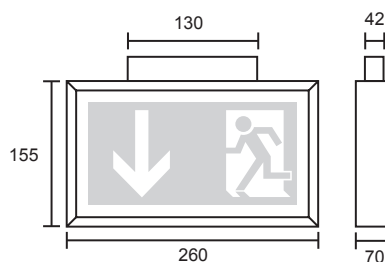

KD Decke / ceiling

Option	Bestellnummer Order number
Pendelpaar 500mm verchromt - Pair of pendant fitting 500mm chromium plated	2PV
Pendelpaar 500mm weiß - Pair of pendants 500mm white	2DW
Design-Seilaufhängung - Cord suspension	DSA
Ballschutzkorb - ball protection	BALL1
Überwachung für Zentralanlagen - monitoring for central power supply systems	BL
Überwachung für Zentralanlagen (alle Schaltungsarten) - monitoring for central power supply systems (all modes)	ML
Überwachung für Einzelbatterie BUS - monitoring for self-contained luminaires BUS	BC
SELF-CONTROL für Einzelbatterie - SELF-CONTROL for self-contained luminaires	SC

### Bohrabstände KD Wand Drilling distances KD wall

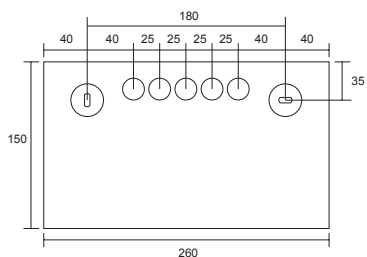

### Bohrabstände KD Decke Drilling distances KD ceiling

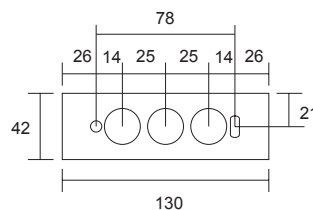

### Zubehör Accessories

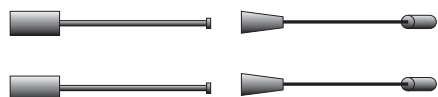



Schlanke Kunststoffleuchte für Universalmontage zur Kennzeichnung und Ausleuchtung der Flucht- und Rettungswege nach DIN EN 60598-1, DIN EN 60598-2-22 und DIN EN 1838. Für ein- oder zweiseitige Beschriftung. Erhältlich als EVG- oder Einzelbatterie-Leuchte.

*Slim plastic luminaire for universal mounting for the marking and lighting of escape and rescue routes according to DIN EN 60598-1, DIN EN 60598-2-22 and EN 1838. For single or double sided labeling. Available for central power systems or as self-contained emergency luminaire.*

<b>Gehäusematerial:</b>	Kunststoff, weiß
<b>Piktogramm:</b>	Folie, Siebdruck RAL 6032
<b>Reflektor:</b>	weiß inkl.
<b>Schutzart/Schutzklasse:</b>	IP54 / II
<b>Montageart:</b>	Universalmontage inkl. Wand, Decke, Wandausleger, Optional: Pendel (P), Kette (K), Seil (S)
<b>Zulässige Umgebungstemp.:</b>	-5° bis +40°C

<b>Body:</b>	Plastic, white
<b>Legend:</b>	Foil, silk-screen printed RAL 6032
<b>Reflector:</b>	white included
<b>Protection class / category:</b>	IP54 / II
<b>Mounting:</b>	Universal mounting incl. wall, ceiling, wall bracket Optionally: Pendant fitting (P), chain (K), cord suspension (S)
<b>Permissible temp.:</b>	-5° up to +40°C

Ausführung Version	Bestellnummer Order number	Überbrückungszeit Operating time	Leuchtmittel Illuminant	Batterie Battery	Lumen lumen	Gewicht kg Weight kg
<b>Leuchten für Zentralanlagen - Luminaires for central power supply systems</b>						
8W 230V EVG	KLU818	-	8W LL	-	450	0,9
11W 230V EVG	KLU825	-	11W CFL	-	900	1,0
LED 230V AC/DC	KLU019	-	LED (3W)	-	150	0,8
<b>Einzelbatterieleuchten - Self-contained luminaires</b>						
8W/3h 230V AC	KLU803	3h	8W LL	3,6V / 3,3Ah	260	1,4
LED 3h 230V AC	KLU013	3h	LED (3W)	12V / 0,8Ah	150	1,2
LED 8h 230V AC	KLU018	8h	LED (3W)	12V / 0,8Ah	75	1,2



## Universal-Kunststoffleuchte Universal Plastic luminaire

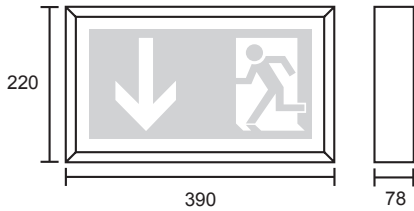

KL Wand / wall

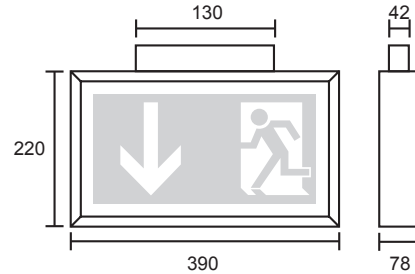

KL Decke / ceiling

Option	Bestellnummer Order number
Pendelpaar 500mm verchromt - Pendant fitting 500mm chromium plated	2PV
Design-Seilaufhängung - Cord suspension	DSA
Ballschutzkorb - ball protection	BALL2
Überwachung für Zentralanlagen - monitoring for central power supply systems	BL
Überwachung für Zentralanlagen (alle Schaltungsarten) - monitoring for central power supply systems (all modes)	ML
Überwachung für Einzelbatterie BUS - monitoring for self-contained luminaires BUS	BC
SELF-CONTROL für Einzelbatterie - SELF-CONTROL for self-contained luminaires	SC

### Bohrabstände KL Wand Drilling distances KL wall

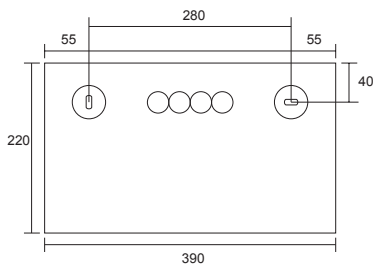

### Bohrabstände KL Decke Drilling distances KL ceiling

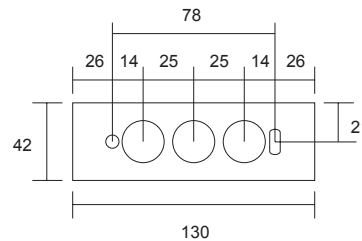

### Zubehör Accessories

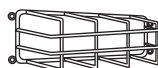
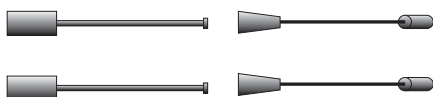

Alle Standardpiktogramme inklusive  
All standard pictographs included



Kunststoffleuchte zur Kennzeichnung und Ausleuchtung der Flucht- und Rettungswege nach DIN EN 60598-1, DIN EN 60598-2-22 und DIN EN 1838. Für ein- oder zweiseitige Beschriftung. Erhältlich als EVG- oder Einzelbatterie-Leuchte.

Plastic luminaire for the marking and lighting of escape and rescue routes according to DIN EN 60598-1, DIN EN 60598-2-22 and EN 1838. For single or double sided labeling. Available for central power systems or as self-contained emergency luminaire.

<b>Gehäusematerial:</b>	Kunststoff, weiß
<b>Piktogramm:</b>	Folie, Siebdruck RAL 6032
<b>Reflektor:</b>	hochglanz Spiegelreflektor
<b>Schutzart/Schutzklasse:</b>	IP54 / II
<b>Montageart:</b>	Wand (W), Decke (D), Pendel (P), Kette (K), Seil (S), Wandausleger AWS
<b>Zulässige Umgebungstemp.:</b>	-5° bis +40°C

<b>Body:</b>	Plastic, white
<b>Legend:</b>	Foil, silk-screen printed RAL 6032
<b>Reflector:</b>	high-polish mirror reflector
<b>Protection class / category:</b>	IP54 / II
<b>Mounting:</b>	wall (W), ceiling (D), Pendant fitting (P), chain (K), cord suspension (S), wall bracket AWS
<b>Permissible temp.:</b>	-5° up to +40°C

Ausführung Version	Bestellnummer Order number	Überbrückungszeit Operating time	Leuchtmittel Illuminant	Batterie Battery	Lumen lumen	Gewicht kg Weight kg
<b>Leuchten für Zentralanlagen - Luminaires for central power supply systems</b>						
8W 230V EVG	KW(W/D/P/K/S)818	-	8W LL	-	450	0,6
11W 230V EVG	KW(W/D/P/K/S)825	-	11W CFL	-	900	0,7
LED 230V AC/DC	KW(W/D/P/K/S)019	-	LED (3W)	-	150	0,6
<b>Einzelbatterieleuchten - Self-contained luminaires</b>						
8W/3h 230V AC	KW(W/D/P/K/S)803	3h	8W LL	3,6V / 3,3Ah	260	0,9
LED/3h 230V AC	KW(W/D/P/K/S)013	3h	LED (3W)	12V / 0,8Ah	150	0,9
LED/8h 230V AC	KW(W/D/P/K/S)018	8h	LED (3W)	12V/ 0,8Ah	75	0,9
Eco-LED/ 3h 230V AC	KW(W/D/P/K/S)003	3h	LED (2W)	3,6V/ 0,5Ah	40	0,9

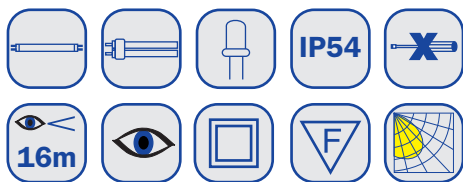

**Universal Piktosatz inklusive!**  
Universal pictograph set included!

## Kunststoffleuchte Plastic luminaire



**Neu • New**

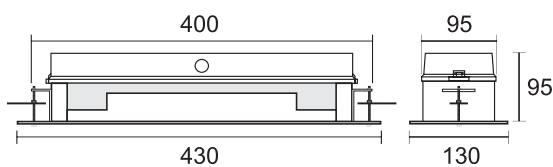

KW Einbaurahmen / recessed frame

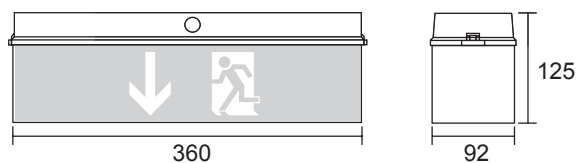

KW Decke / ceiling

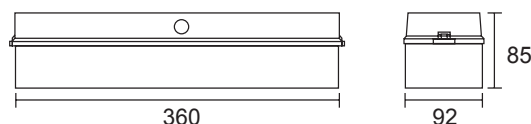

KW Wand / wall

Option	Bestellnummer Order number
Glasklare Wandhaube - crystal-clear wall cover	KWC
Einbaurahmen - Recessed frame	KWE
Pendelpaar 500mm verchromt - Pendant fitting 500mm chromium plated	2PV
Design-Seilaufhängung - Cord suspension	DSA
Wandausleger - wall bracket	AWS
Ballschutzkorb - ball protection	BKW
Überwachung für Zentralanlagen - monitoring for central power supply systems	BL
Überwachung für Zentralanlagen (alle Schaltungsarten) - monitoring for central power supply systems (all modes)	ML
Überwachung für Einzelbatterie BUS - monitoring for self-contained luminaires BUS	BC
SELF-CONTROL für Einzelbatterie - SELF-CONTROL for self-contained luminaires	SC

### Bohrabstände KW Drilling distances KW

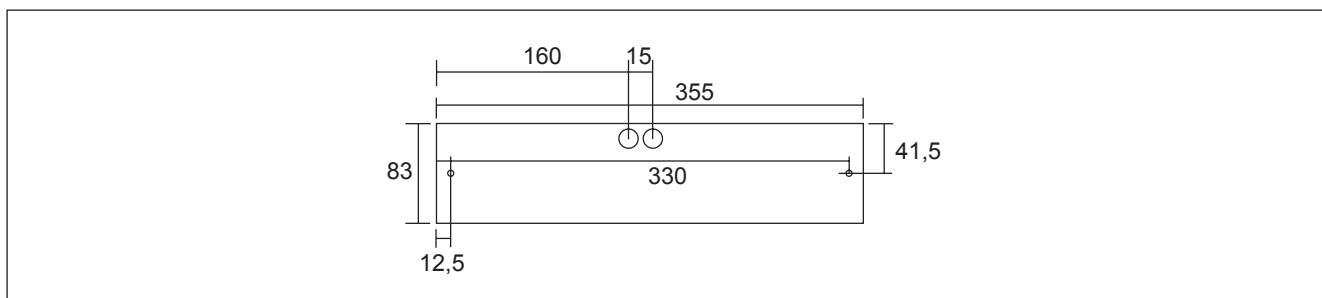

### Zubehör Accessories

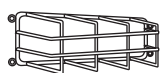
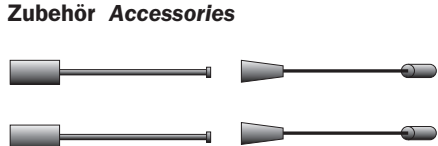

Alle Standardpiktogramme inklusive  
All standard pictographs included



PF Wand mit Prismatik Haube / PF wall with prismatic cover

Kunststoffleuchte zur Kennzeichnung und Ausleuchtung der Flucht- und Rettungswege nach DIN EN 60598-1, DIN EN 60598-2-22 und DIN EN 1838. Für ein- oder zweiseitige Beschriftung. Erhältlich als EVG- oder Einzelbatterie-Leuchte.

Plastic luminaire for the marking and lighting of escape and rescue routes according to DIN EN 60598-1, DIN EN 60598-2-22 and EN 1838. For single or double sided labeling. Available for central power systems or as self-contained emergency luminaire.

<b>Gehäusematerial:</b>	Kunststoff, weiß
<b>Piktogramm:</b>	Folie, Siebdruck RAL 6032
<b>Schutzart/Schutzklasse:</b>	IP65 / II
<b>Montageart:</b>	Wand (W), Decke (D), Einbau (E), Pendel (P), Kette (K), Seil (S), Wandausleger AWS
<b>Zulässige Umgebungstemp.:</b>	-5° bis +40°C

<b>Body:</b>	Plastic, white
<b>Legend:</b>	Foil, silk-screen printed RAL 6032
<b>Protection class / category:</b>	IP65 / II
<b>Mounting:</b>	wall (W), ceiling (D), recessed (E), Pendant fitting (P), chain (K), cord suspension (S), wall bracket AWS
<b>Permissible temp.:</b>	-5° up to +40°C

Ausführung Version	Bestellnummer Order number	Überbrückungszeit Operating time	Leuchtmittel Illuminant	Batterie Battery	Lumen lumen	Gewicht kg Weight kg
<b>Leuchten für Zentralanlagen - Luminaires for central power supply systems</b>						
8W 230V EVG	PF(W/D/E/P/K/S)818	-	8W LL	-	450	1,0
LED 230V AC/DC	PF(W/D/E/P/K/S)019	-	LED (3W)	-	150	1,0
11W 230V EVG	PF(W/D/E/P/K/S)825	-	11W CFL	-	900	1,1
18W 230V EVG	PF(W/D/E/P/K/S)835	-	18W CFL	-	1350	1,2
<b>Einzelbatterieleuchten - Self-contained luminaires</b>						
11W/1h 230V AC	PF(W/D/E/P/K/S)809	1h	11W CFL	6,0V / 1,3Ah	350	1,5
8W/3h 230V AC	PF(W/D/E/P/K/S)803	3h	8W LL	3,6V / 3,3Ah	260	1,5
LED/3h 230V AC	PF(W/D/E/P/K/S)013	3h	LED (3W)	12V / 0,8Ah	150	1,5
11W/3h 230V AC	PF(W/D/E/P/K/S)811	3h	11W CFL	6,0V / 4,0Ah	350	1,7
LED/8h 230V AC	PF(W/D/E/P/K/S)018	8h	LED (3W)	12V / 0,8Ah	75	1,5

## Kunststoffleuchte Plastic luminaire



**Universal  
Piktosatz  
inklusive!**  
Universal  
pictograph set  
included!

**Auch erhältlich als PF Cool  
speziell für Kühllhäuser**

**Also available as PF Cool  
for cold storage houses**

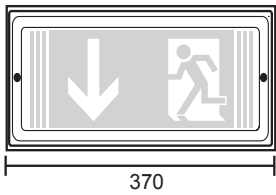

PF Wand / wall

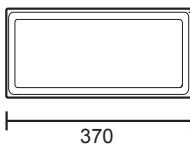
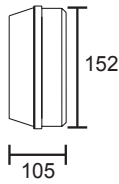

PF Decke / ceiling

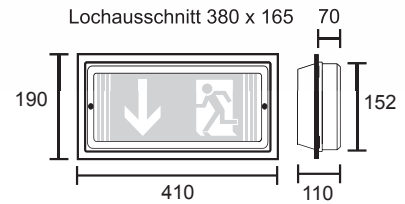

PF Einbau / recessed

Option	Bestellnummer Order number
Einbaurahmen - recessed frame	PFER
Prismatik-Haube - prismatic cover	PRPF
PF Cool (IP65, Wandmontage) - PF Cool (IP65, wall mounting)	PFC
Pendelpaar 500mm verchromt (kein IP65) - Pendant fitting 500mm chromium plated (not IP65)	2PV
Design-Seilaufhängung (kein IP65) - Cord suspension (not IP65)	DSA
Ballschutzkorb (nur Wand) - ball protection (wall only)	BALL2
Wandausleger - wall bracket	AWS
Überwachung für Zentralanlagen - monitoring for central power supply systems	BL
Überwachung für Zentralanlagen (alle Schaltungsarten) - monitoring for central power supply systems (all modes)	ML
Überwachung für Einzelbatterie BUS - monitoring for self-contained luminaires BUS	BC
SELF-CONTROL für Einzelbatterie - SELF-CONTROL for self-contained luminaires	SC

### Bohrabstände PF Drilling distances PF

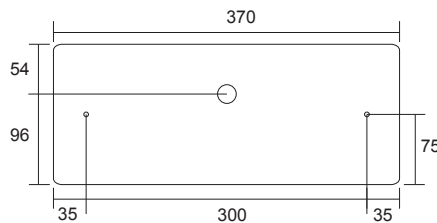

Zusätzliche Kabeleinführungen  
auf allen 4 Seiten mittig

### Zubehör Accessories

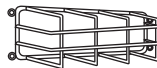
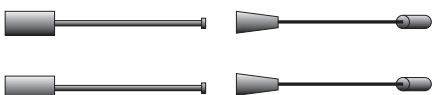

\* - Nicht für den Einsatz in Schwimmbädern oder Schlachthöfen geeignet (nicht chlor- / chemikalienbeständig)  
Not suitable for use in pool areas or slaughterhouses (not chlorine- / chemical persistent)



Industrie-Kunststoffleuchte mit PG-Verschraubung zur Kennzeichnung und Ausleuchtung der Flucht- und Rettungswege nach DIN EN 60598-1, DIN EN 60598-2-22 und DIN EN 1838. Erhältlich als EVG- oder Einzelbatterie-Leuchte.

Industry plastic luminaire with cone screws for the marking and lighting of escape and rescue routes according to DIN EN 60598-1, DIN EN 60598-2-22 and EN 1838. Available for central power systems or as self-contained emergency luminaire.

<b>Gehäusematerial:</b>	Kunststoff, grau
<b>Piktogramm:</b>	Folie, Siebdruck RAL 6032 (Piktogramm angeben!)
<b>Schutzart/Schutzklasse:</b>	IP65 / II
<b>Montageart:</b>	Wand (W)
<b>Zulässige Umgebungstemp.:</b>	-5° bis +40°C

<b>Body:</b>	Plastic, grey
<b>Legend:</b>	Foil, silk-screen printed RAL 6032 (specify pictograph!)
<b>Protection class / category:</b>	IP65 / II
<b>Mounting:</b>	wall (W)
<b>Permissible temp.:</b>	-5° up to +40°C

Ausführung Version	Bestellnummer Order number	Überbrückungszeit Operating time	Leuchtmittel Illuminant	Batterie Battery	Lumen lumen	Gewicht kg Weight kg
<b>Leuchten für Zentralanlagen - Luminaires for central power supply systems</b>						
8W 230V EVG	IPW818	-	8W LL	-	450	0,8
11W 230V EVG	IPW825	-	11W CFL	-	900	0,9
LED 230V AC/DC	IPW019	-	LED (3W)	-	150	0,8
<b>Einzelbatterieleuchten - Self-contained luminaires</b>						
11W/1h 230V AC	IPW809	1h	11W CFL	6,0V / 1,3Ah	350	1,3
8W/3h 230V AC	IPW803	3h	8W LL	3,6V / 3,3Ah	260	1,2
LED/3h 230V AC	IPW013	3h	LED (3W)	12V / 0,8Ah	150	1,2
11W/3h 230V AC	IPW811	3h	11W CFL	6,0V / 4,0Ah	350	1,3
LED/8h 230V AC	IPW018	8h	LED (3W)	12V / 0,8Ah	75	1,2



## Industrie-Kunststoffleuchte Industry plastic luminaire

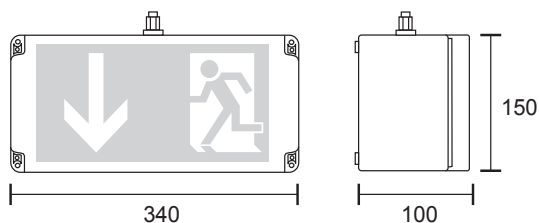

Bitte  
Piktogramm  
angeben!  
Please specify  
pictograph!



IP Wand / wall mounting

Option	Bestellnummer Order number
Ballschutzkorb - ball protection	BALL2
Überwachung für Zentralanlagen - monitoring for central power supply systems	BL
Überwachung für Zentralanlagen (alle Schaltungsarten) - monitoring for central power supply systems (all modes)	ML
Überwachung für Einzelbatterie BUS - monitoring for self-contained luminaires BUS	BC
SELF-CONTROL für Einzelbatterie - SELF-CONTROL for self-contained luminaires	SC

### Bohrabstände IP Drilling distances IP

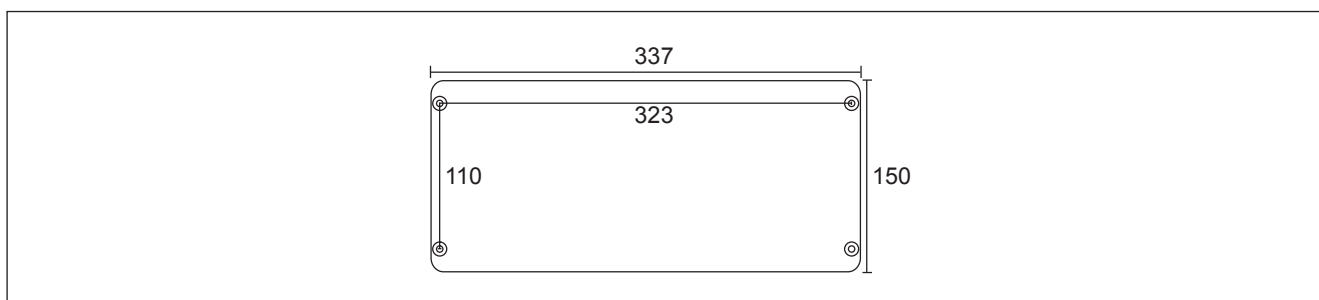

### Zubehör Accessories



\* – Nicht für den Einsatz in Schwimmbädern oder Schlachthöfen geeignet (nicht chlor- / chemikalienbeständig)  
Not suitable for use in pool areas or slaughterhouses (not chlorine- / chemical persistent)



Würfel-Kunststoffleuchte zur Kennzeichnung und Ausleuchtung der Flucht- und Rettungswege nach DIN EN 60598-1, DIN EN 60598-2-22 und DIN EN 1838. Für ein- bis vierseitige Beschriftung. Erhältlich als EVG- oder Einzelbatterie-Leuchte.

Plastic cubic luminaire for the marking and lighting of escape and rescue routes according to DIN EN 60598-1, DIN EN 60598-2-22 and EN 1838. For single- up to four sided labeling. Available for central power systems or as self-contained emergency luminaire.

<b>Gehäusematerial:</b>	Kunststoff weiß, Zinkor
<b>Piktogramm:</b>	Folie, Siebdruck RAL 6032
<b>Erkennungsweite:</b>	WK: 36m, WG: 46m, WX: 90m
<b>Leuchtmittel:</b>	WK: 4W LL oder LED (1,5W) WG: 9W CFL oder LED (3W) WX: 26W CFL oder LED (3W optional 6W)
<b>Montageart:</b>	Wand (W), Decke (D), Pendel (P), Kette (K)
<b>Zulässige Umgebungtemp.:</b>	-5° bis +40°C

<b>Body:</b>	Plastic white, zinc steel sheet
<b>Legend:</b>	Foil, silk-screen printed RAL 6032
<b>Viewing distance:</b>	WK: 36m, WG: 46m, WX: 90m
<b>Illuminant:</b>	WK: 4W LL oder LED (1,5W) WG: 9W CFL oder LED (3W) WX: 26W CFL oder LED (3W optionally 6W)
<b>Mounting:</b>	wall (W), ceiling (D), pendant fitting (P), chain (K)
<b>Permissible temp.:</b>	-5° up to +40 °C

## Würfel-Kunststoffleuchten Plastic cube luminaires

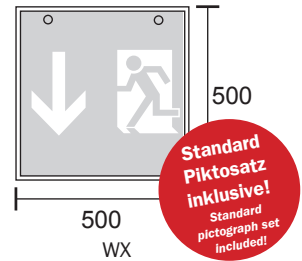
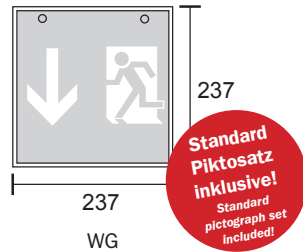
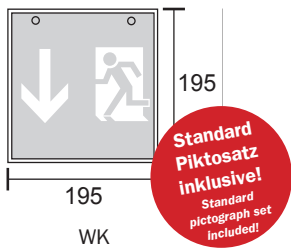

Ausführung Version	Bestellnummer Order number	Überbrückungszeit Operating time	Leuchtmittel Illuminant	Batterie Battery	Lumen lumen	Gewicht kg Weight kg
<b>Leuchten für Zentralanlagen - Luminaires for central power supply systems</b>						
4W 230V EVG	WK(W/D/P/K)406	-	4W LL	-	140	0,8
LED 230V AC/DC	WK(W/D/P/K)019	-	LED (1,5W)	-	75	0,7
9W 230V EVG	WG(W/D/P/K)619	-	9W CFL	-	600	1,0
LED 230V AC/DC	WG(W/D/P/K)019	-	LED (3W)	-	150	0,9
26W 230V EVG	WX(W/D/P/K)260	-	26W	-	1800	1,4
LED 230V AC/DC	WX(W/D/P/K)019	-	LED (3W)	-	150	1,3

<b>Einzelbatterieleuchten - Self-contained luminaires</b>						
9W/3h 230V AC	WG(W/D/P/K)621	3h	9W CFL	3,6V / 3,3Ah	350	1,85
LED 3h 230V AC	WG(W/D/P/K)013	3h	LED (3W)	12V / 0,8Ah	150	1,7
26W/1h 230V AC	WX(W/D/P/K)261	1h	26W CFL	6,0V / 1,8Ah	750	2,1
26W/3h 230V AC	WX(W/D/P/K)263	3h	26W CFL	6,0V / 4,0Ah	750	2,3
LED 3h 230V AC	WX(W/D/P/K)013	3h	LED (3W)	12V / 0,8Ah	150	2,0

Option	Bestellnummer Order number
Pendel 500mm verchromt - Pendant fitting 500mm chromium plated	1PV
Überwachung für Zentralanlagen - monitoring for central power supply systems	BL
Überwachung für Zentralanlagen (alle Schaltungsarten) - monitoring for central power supply systems (all modes)	ML
Überwachung für Einzelbatterie BUS - monitoring for self-contained luminaires BUS	BC
SELF-CONTROL für Einzelbatterie - SELF-CONTROL for self-contained luminaires	SC

Bohrabstände WK Drilling distances WK	Bohrabstände WG Drilling distances WG	Bohrabstände WX Drilling distances WX

### Zubehör Accessories





Würfel-Kunststoffleuchte zur Kennzeichnung und Ausleuchtung der Flucht- und Rettungswege nach DIN EN 60598-1, DIN EN 60598-2-22 und DIN EN 1838. Für ein- bis vierseitige Beschriftung. Erhältlich als EVG- oder Einzelbatterie-Leuchte.

*Plastic cubic luminaire for the marking and lighting of escape and rescue routes according to DIN EN 60598-1, DIN EN 60598-2-22 and EN 1838. For single- up to four sided labeling. Available for central power systems or as self-contained emergency luminaire.*

<b>Gehäusematerial:</b>	Kunststoff, Zinkor - weiß
<b>Piktogramm:</b>	Folie, Siebdruck RAL 6032 (Bitte Piktogramm angeben!)
<b>Erkennungsweite:</b>	W1: 36m, W2: 48m
<b>Leuchtmittel:</b>	W1: 9W PL oder LED (3W) W2: 26W PL oder LED (3W)
<b>Montageart:</b>	Wand (W), Decke (D), Pendel (P), Kette (K)
<b>Zulässige Umgebungtemp.:</b>	-5° bis +40°C

<b>Body:</b>	Plastic, zinc steel sheet - white
<b>Legend:</b>	Foil, silk-screen printed RAL 6032 (please specify pictograph!)
<b>Viewing distance:</b>	W1: 36m, W2: 48m
<b>Illuminant:</b>	W1: 9W CFL or LED (3W) W2: 26W CFL or LED (3W)
<b>Mounting:</b>	wall (W), ceiling (D), pendant fitting (P), chain (K)
<b>Permissible temp.:</b>	-5° up to +40°C



## Würfel-Kunststoffleuchten Plastic cube luminaires

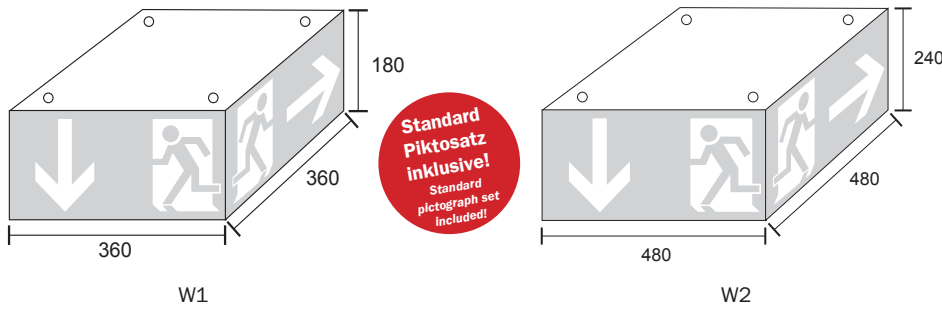

Ausführung Version	Bestellnummer Order number	Überbrückungszeit Operating time	Leuchtmittel Illuminant	Batterie Battery	Lumen lumen	Gewicht kg Weight kg
-----------------------	-------------------------------	-------------------------------------	----------------------------	---------------------	----------------	-------------------------

### Leuchten für Zentralanlagen - Luminaires for central power supply systems

9W 230V EVG	W1(W/D/P/K)619	-	9W CFL	-	600	1,3
LED 230V AC/DC	W1(W/D/P/K)019	-	LED (3W)	-	150	1,2
26W 230V EVG	W2(W/D/P/K)260	-	26W CFL	-	1800	1,9
LED 230V AC/DC	W2(W/D/P/K)019	-	LED (3W)	-	150	1,8

### Einzelbatterieleuchten - Self-contained luminaires

9W/3h 230V AC	W1(W/D/P/K)621	3h	9W CFL	3,6V / 3,3Ah	350	1,7
LED 3h 230V AC	W1(W/D/P/K)013	3h	LED (3W)	12V / 0,8Ah	150	1,6
26W/1h 230V AC	W2(W/D/P/K)261	1h	26W CFL	6,0V / 1,8Ah	750	2,2
26W/3h 230V AC	W2(W/D/P/K)263	3h	26W CFL	6,0V / 4,0Ah	750	2,4
LED 3h 230V AC	W2(W/D/P/K)013	3h	LED (3W)	12V / 0,8Ah	150	2,0

Option	Bestellnummer Order number
Pendel 500mm verchromt - Pendant fitting 500mm chromium plated	1PV
Überwachung für Zentralanlagen - monitoring for central power supply systems	BL
Überwachung für Zentralanlagen (alle Schaltungsarten) - monitoring for central power supply systems (all modes)	ML
Überwachung für Einzelbatterie BUS - monitoring for self-contained luminaires BUS	BC
SELF-CONTROL für Einzelbatterie - SELF-CONTROL for self-contained luminaires	SC

### Bohrabstände W1 Drilling distances W1

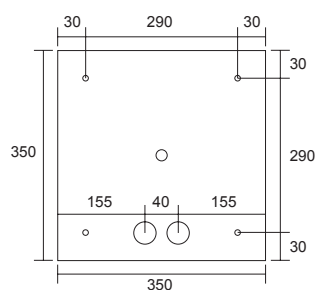

### Bohrabstände W2 Drilling distances W2

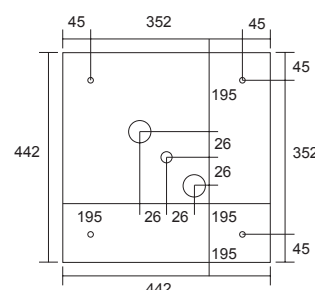

### Zubehör Accessories

